

Model No.GB602W BENCH GRINDER 150MM

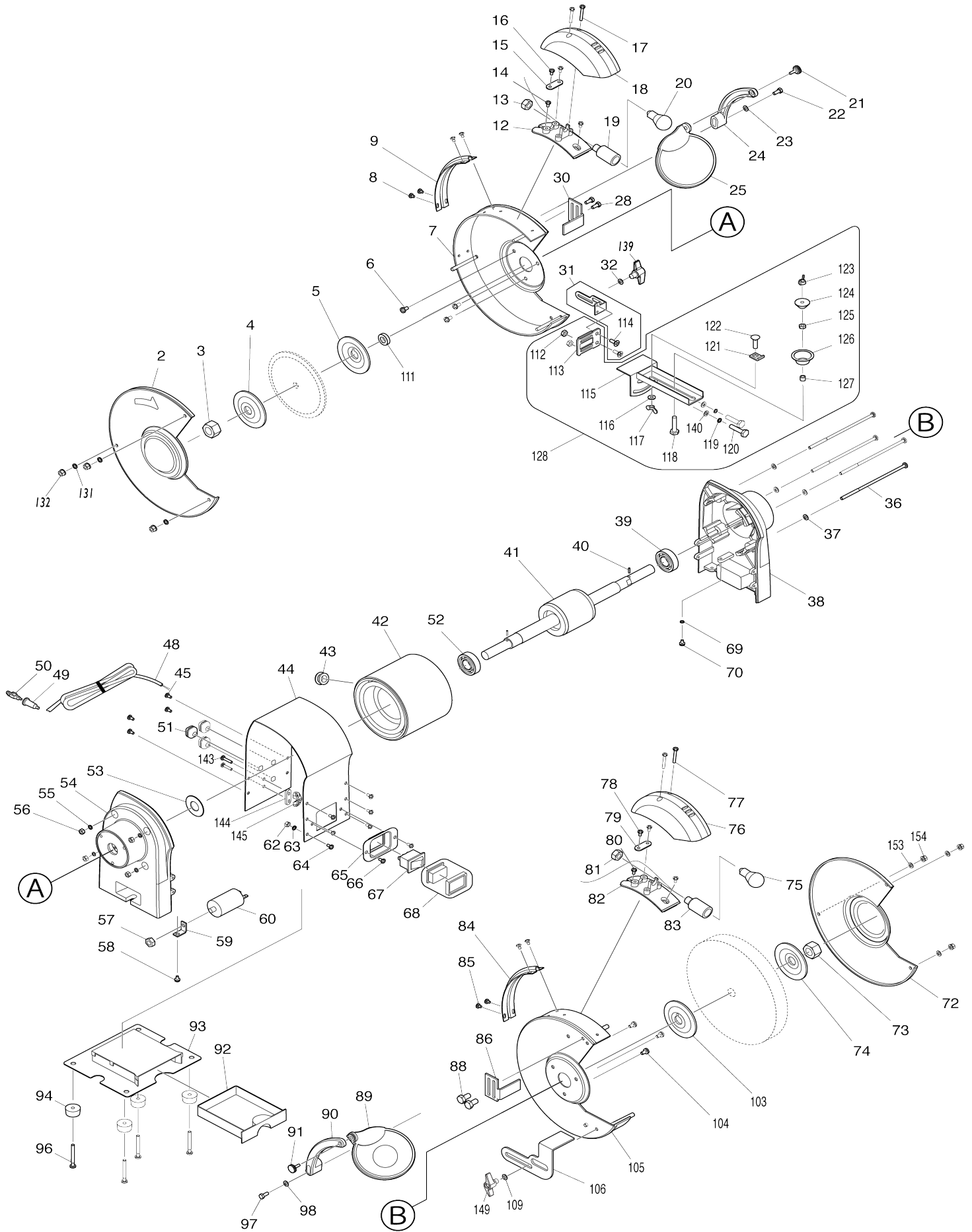

Model No.GB602W BENCH GRINDER 150MM

Item No.	Parts No.	Description	Interchangability	Q'ty	New/Old	Note1	Note2
001	911274-7	PAN HEAD SCREW M5X50		2	*		
002	AL00000201	LEFT WHEEL COVER		1	*		
002-1	AL00000201	LEFT WHEEL COVER	O	1			
003	AL00000003	HEX NUT M12 LH		1	*		
003-1	AL00000003	HEX NUT M12 LH	O	1			
004	AL00000004	OUTER FLANGE 60		1	*		
004-1	AL00000004	OUTER FLANGE 60	O	1			
005	AL00000005	INNER FLANGE 60		1	*		
005-1	AL00000005	INNER FLANGE 60	O	1			
006	911206-4	PAN HEAD SCREW M5X10		3	*		
006-1	AL00000304	PAN HEAD SCREW M5X10 WITH W	X	3			
007	AL00000203	LEFT WHEEL GUARD (INNER)		1	*		
007-1	AL00000203	LEFT WHEEL GUARD (INNER)	O	1	*		
007-2	AL00000255	LEFT WHEEL GUARD (INNER)	X	1			
008	911107-6	PAN HEAD SCREW M4X8		4	*		
008-1	AL00000114	PAN HEAD SCREW M4X6	X	4			
009	AL00000007	CORD CLAMP		1			
010	942101-7	SPRING WASHER 5		1	*		
011	931201-8	HEX. NUT M5		1	*		
012	AL00000008	LAMP COVER BASE		1			
013	AL00000009	PLASTIC HEX NUT M10		1	*		
013-1	AL00000009	PLASTIC HEX NUT M10	O	1			
014	911107-6	PAN HEAD SCREW M4X8		2	*		
014-1	AL00000102	BIND HEAD SCREW M4X6	X	2			
015	AL00000010	CORD CLAMP BASE		1	*		
015-1	AL00000010	CORD CLAMP BASE	O	1			
016	911118-1	PAN HEAD SCREW M4X12		2	*		
016-1	AL00000104	PAN HEAD SCREW M4X10	X	2			
017	911156-3	PAN HEAD SCREW M4X30		2	*		
017-1	AL00000105	PAN HEAD SCREW M4X30	O	2			
018	AL00000011	LAMP COVER ASSY		1	*		
018-1	AL00000011	LAMP COVER ASSY	O	1	*		
018-2	AL00000310	LAMP COVER ASSY	O	1			
019	AL00000012	LAMP SOCKET S-25		1	*		
019-1	AL00000012	LAMP SOCKET S-25	O	1			
020	AL00000013	BULB S-25 12V 10W		1	*		
020-1	AL00000013	BULB S-25 12V 10W	O	1			
021	AL00000014	KNOB BOLT M4X12		1	*		
021-1	AL00000014	KNOB BOLT M4X12	O	1			
022	921351-7	HEX. BOLT M6X30		1	*		
022-1	AL00000119	HEX BOLT M6X30	O	1			
023	941151-9	FLAT WASHER 6		1	*		
023-1	AL00000127	FLAT WASHER 6	O	1			
024	AL00000015	EYE SHIELD MOUNTING ARM L		1	*		
024-1	AL00000015	EYE SHIELD MOUNTING ARM L	O	1			
025	AL00000016	EYE SHIELD L ASSY		1	*		
025-1	AL00000016	EYE SHIELD L ASSY	O	1			

026	931201-8	HEX. NUT M5		1	*		
027	942101-7	SPRING WASHER 5		1	*		
028	921212-1	HEX. BOLT M5X12		1	*		
028-1	AL00000252	HEX BOLT M5X10 WITH WR	X	1			
029	942101-7	SPRING WASHER 5		1	*		
030	AL00000017	LEFT SPARK SHIELD		1	*		
030-1	AL00000017	LEFT SPARK SHIELD	O	1			
031	AL00000082	WORK REST FOR SHARPENING KI T A		1	*		
031-1	AL00000082	WORK REST FOR SHARPENING KI T A	O	1			
D10		INC. 114					
032	941202-8	FLAT WASHER 8		2	*		
032-1	AL00000128	FLAT WASHER 8	O	2	*		
032-2	AL00000128	FLAT WASHER 8	X	1			
033	942101-7	SPRING WASHER 5		1	*		
034	931201-8	HEX. NUT M5		1	*		
035	921411-5	HEX. BOLT M8X12		2	*		
035-1	AL00000118	HEX BOLT M8X10	O	2	*		
036	265004-1	PAN HEAD SCREW M5X135		4	*		
036-1	AL00000113	PAN HEAD SCREW M5X135	O	4	*		
036-2	AL00000113	PAN HEAD SCREW M5X135	O	4			
037	941101-4	FLAT WASHER 5		4	*		
037-1	AL00000126	FLAT WASHER 5	O	4			
038	AL00000019	HOUSING R		1	*		
038-1	AL00000019	HOUSING R	O	1			
039	211206-7	BALL BEARING 6202LLB		1	*		
039-1	AL00000100	BALL BEARING 6202	O	1			
040	951051-5	SPRING PIN 3-8		2	*		
040-1	AL00000135	SPRING PIN 3X8	O	2			
041	AL00000215	ROTOR		1	*		
041-1	AL00000229	ROTOR	S	1			
042	AL00000185	STATOR 220V 50HZ		1	*		
042-1	AL00000228	STATOR 220-240V 50HZ	S	1	*		
042-2	AL00000228	STATOR 220-240V 50HZ	O	1	*		
042-3	AL00000261	STATOR 220-240V 50-60HZ	X	1			
043	AL00000022	GROMMET		1	*		
043-1	AL00000022	GROMMET	O	1			
044	AL00000183	HOUSING CENTER		1	*		
044-1	AL00000183	HOUSING CENTER	O	1	*		
044-2	AL00000259	HOUSING CENTER	X	1			
045	911113-1	PAN HEAD SCREW M4X10 WITH WR		4	*		
045-1	AL00000108	PAN HEAD SCREW M4X8	X	4			
046	AL00000192	CORD CLIP PLATE (2 HOLES)		1	*		
046-1	AL00000192	CORD CLIP PLATE (2 HOLES)	O	1	*		
047	911113-1	PAN HEAD SCREW M4X10 WITH WR		2	*		
047-1	AL00000103	PAN HEAD SCREW M4X8	X	2	*		
048	AL00000152	POWER SUPPLY CORD EURO 3P		1	*		
048-1	AL00000152	POWER SUPPLY CORD EURO 3P	O	1			
051	AL00000026	GROMMET WITH STRAIN RELIEF		3	*		

051-1	AL00000026	GROMMET WITH STRAIN RELIEF	O	3	*		
051-2	AL00000026	GROMMET WITH STRAIN RELIEF	O	2	*		
051-3	AL00000026	GROMMET WITH STRAIN RELIEF	O	3			
052	211206-7	BALL BEARING 6202LLB		1	*		
052-1	AL00000100	BALL BEARING 6202	O	1			
053	AL00000027	WAVE SPRING WASHER 27.5		1	*		
053-1	AL00000027	WAVE SPRING WASHER 27.5	O	1			
054	AL00000028	HOUSING L		1	*		
054-1	AL00000028	HOUSING L	O	1			
055	942101-7	SPRING WASHER 5		4	*		
055-1	AL00000132	SPRING WASHER 5	O	4			
056	931201-8	HEX. NUT M5		4	*		
056-1	AL00000121	HEX NUT M5	O	4			
057	931402-8	HEX. NUT M8		1	*		
057-1	AL00000122	HEX NUT M8	O	1			
058	911113-1	PAN HEAD SCREW M4X10 WITH WR		1	*		
058-1	AL00000295	PAN HEAD SCREW M4X7 WITH W G	O	1			
059	AL00000029	CAPACITOR SUPPORT		1	*		
059-1	AL00000029	CAPACITOR SUPPORT	O	1			
060	AL00000095	CAPACITOR 4 MICRO F/450V		1	*		
060-1	AL00000095	CAPACITOR 4 MICRO F/450V	O	1	*		
060-2	AL00000249	CAPACITOR 4 MICRO F/450V	<	1			
061	942051-6	SPRING WASHER 4		2	*		
061-1	AL00000131	SPRING WASHER 4	O	2	*		
062	931102-0	HEX. NUT M4		4	*		
062-1	AL00000120	HEX NUT M4	O	4	*		
062-2	AL00000120	HEX NUT M4	O	2			
063	942051-6	SPRING WASHER 4		2	*		
063-1	AL00000131	SPRING WASHER 4	O	2			
064	911113-1	PAN HEAD SCREW M4X10 WITH WR		6	*		
064-1	AL00000108	PAN HEAD SCREW M4X8	X	6			
065	AL00000031	SWITCH BOARD		1			
066	911113-1	PAN HEAD SCREW M4X10 WITH WR		2	*		
066-1	AL00000103	PAN HEAD SCREW M4X8	X	2			
067	AL00000032	SWITCH ASSY COVER		1	*		
067-1	AL00000168	SWITCH WITH COVER	<	1			
068	AL00000033	SWITCH COVER ASSY		1	*		
069	AL00000134	TOOTHED LOCK WASHER 4		1			
070	911113-1	PAN HEAD SCREW M4X10 WITH WR		1	*		
070-1	AL00000295	PAN HEAD SCREW M4X7 WITH W G	O	1			
072	AL00000218	RIGHT WHEEL COVER		1	*		
072-1	AL00000218	RIGHT WHEEL COVER	O	1			
073	AL00000035	HEX NUT M12		1			
074	AL00000004	OUTER FLANGE 60		1	*		
074-1	AL00000004	OUTER FLANGE 60	O	1			
075	AL00000013	BULB S-25 12V 10W		1	*		
075-1	AL00000013	BULB S-25 12V 10W	O	1			

076	AL00000011	LAMP COVER ASSY		1	*		
076-1	AL00000011	LAMP COVER ASSY	O	1	*		
076-2	AL00000310	LAMP COVER ASSY	O	1			
077	911156-3	PAN HEAD SCREW M4X30		2	*		
077-1	AL00000105	PAN HEAD SCREW M4X30	O	2			
078	911118-1	PAN HEAD SCREW M4X12		2	*		
078-1	AL00000104	PAN HEAD SCREW M4X10	X	2			
079	AL00000010	CORD CLAMP BASE		1	*		
079-1	AL00000010	CORD CLAMP BASE	O	1			
080	911107-6	PAN HEAD SCREW M4X8		2	*		
080-1	AL00000102	BIND HEAD SCREW M4X6	X	2			
081	AL00000009	PLASTIC HEX NUT M10		1	*		
081-1	AL00000009	PLASTIC HEX NUT M10	O	1			
082	AL00000008	LAMP COVER BASE		1			
083	AL00000012	LAMP SOCKET S-25		1	*		
083-1	AL00000012	LAMP SOCKET S-25	O	1			
084	AL00000007	CORD CLAMP		1			
085	911107-6	PAN HEAD SCREW M4X8		4	*		
085-1	AL00000114	PAN HEAD SCREW M4X6	X	4			
086	AL00000036	RIGHT SPARK SHIELD		1	*		
086-1	AL00000036	RIGHT SPARK SHIELD	O	1			
087	942101-7	SPRING WASHER 5		1	*		
088	921212-1	HEX. BOLT M5X12		1	*		
088-1	AL00000252	HEX BOLT M5X10 WITH WR	X	1			
089	AL00000037	EYE SHIELD WITH MAGNIFYER		1	*		
089-1	AL00000037	EYE SHIELD WITH MAGNIFYER	O	1			
090	AL00000038	EYE SHIELD MOUNTING ARM R		1	*		
090-1	AL00000038	EYE SHIELD MOUNTING ARM R	O	1			
091	AL00000014	KNOB BOLT M4X12		1	*		
091-1	AL00000014	KNOB BOLT M4X12	O	1			
092	AL00000039	COOLANT TRAY		1			
093	AL00000040	UNDER COVER		1	*		
093-1	AL00000040	UNDER COVER	O	1			
094	AL00000041	PUBBER FOOT		4	*		
094-1	AL00000041	PUBBER FOOT	O	4			
095	941051-3	FLAT WASHER 4		4	*		
095-1	AL00000129	FLAT WASHER 4 (L)	X	4	*		
096	911121-2	PAN HEAD SCREW M4X14		4	*		
096-1	AL00000109	PAN HEAD SCREW M4X16 WITH R	X	4	*		
096-2	AL00000305	PAN HEAD SCREW M4X16 WITH R	X	4			
097	921351-7	HEX. BOLT M6X30		1	*		
097-1	AL00000119	HEX BOLT M6X30	O	1			
098	941151-9	FLAT WASHER 6		1	*		
098-1	AL00000127	FLAT WASHER 6	O	1			
099	931201-8	HEX. NUT M5		1	*		
100	942101-7	SPRING WASHER 5		1	*		
101	931201-8	HEX. NUT M5		1	*		
102	942101-7	SPRING WASHER 5		1	*		
103	AL00000005	INNER FLANGE 60		1	*		
103-1	AL00000005	INNER FLANGE 60	O	1			

104	911206-4	PAN HEAD SCREW M5X10		3	*		
104-1	AL00000304	PAN HEAD SCREW M5X10 WITH W	X	3			
105	AL00000207	WHEEL COVER R(INNER)		1	*		
105-1	AL00000256	RIGHT WHEEL GUARD (INNER)	X	1			
106	AL00000043	RIGHT WORK REST		1	*		
106-1	AL00000043	RIGHT WORK REST	O	1			
107	942101-7	SPRING WASHER 5		1	*		
108	931201-8	HEX. NUT M5		1	*		
109	941202-8	FLAT WASHER 8		2	*		
109-1	AL00000128	FLAT WASHER 8	O	2	*		
109-2	AL00000128	FLAT WASHER 8	X	1			
110	921411-5	HEX. BOLT M8X12		2	*		
110-1	AL00000118	HEX BOLT M8X10	O	2	*		
111	AL00000001	SPACER RING 12.7X27X6.7		1	*		
111-1	AL00000001	SPACER RING 12.7X27X6.7	O	1			
112	931301-4	HEX. NUT M6		2	*		
112-1	AL00000123	HEX NUT M6	O	2			
113	AL00000047	WORK REST FOR SHARPENING KIT B		1	*		
113-1	AL00000047	WORK REST FOR SHARPENING KIT B	O	1			
114	AL00000048	FLAT HEAD SCREW M6X10		2	*		
114-1	AL00000048	FLAT HEAD SCREW M6X10	O	2			
115	AL00000049	SAW BLADE SHARPENER STAND		1	*		
115-1	AL00000049	SAW BLADE SHARPENER STAND	O	1			
116	AL00000050	THICK FLAT WASHER 10		1	*		
116-1	AL00000050	THICK FLAT WASHER 10	O	1			
117	934401-9	WING NUT M8		1	*		
117-1	AL00000124	WING NUT M8	O	1			
118	921362-2	HEX. BOLT M6X40		1	*		
118-1	AL00000117	HEX BOLT M6X40	O	1			
119	942151-2	SPRING WASHER 6		2	*		
119-1	AL00000133	SPRING WASHER 6	O	2			
120	921362-2	HEX. BOLT M6X40		2	*		
120-1	AL00000145	HEX BOLT M6X16	X	2			
121	AL00000051	STOPPER PLATE		1	*		
121-1	AL00000051	STOPPER PLATE	O	1			
122	AL00000052	SQUARE NECK BOLT M8X20		1	*		
122-1	AL00000052	SQUARE NECK BOLT M8X20	O	1			
123	934301-3	WING NUT M6		1	*		
123-1	AL00000125	WING NUT M6	O	1			
124	AL00000053	SAW BLADE CLAMP CONE		1	*		
124-1	AL00000053	SAW BLADE CLAMP CONE	O	1			
125	931301-4	HEX. NUT M6		1	*		
125-1	AL00000123	HEX NUT M6	O	1			
126	AL00000054	SAW BLADE CLAMP CUP		1	*		
126-1	AL00000054	SAW BLADE CLAMP CUP	O	1			
127	AL00000055	SPACER SLEEVE 6X8X6		1	*		
127-1	AL00000055	SPACER SLEEVE 6X8X6	O	1			
128	A-47531	SAW BLADE SHARPENING KIT		1			
D10		INC. 31,112-127					

D11		INC. 112,113,115-127,140				
129	911267-4	PAN HEAD SCREW M5X45		4	*	
131	AL00000127	FLAT WASHER 6		3		
132	AL00000204	HEX NUT M6		3		
137	AL00000133	SPRING WASHER 6		1		
138	AL00000018	LEFT WORK REST		1		
139	AL00000253	KNOB BOLT M8X9		1		
140	AL00000127	FLAT WASHER 6		2		
142	AL00000180	CORD GUARD WITH STRAIN RELIEF		1	*	
143	AL00000251	PAN HEAD SCREW M4X16		2		
144	AL00000010	CORD CLAMP BASE		1		
145	AL00000254	CORD CLAMP		1		
148	AL00000133	SPRING WASHER 6		1		
149	AL00000253	KNOB BOLT M8X9		1		
153	AL00000127	FLAT WASHER 6		3		
154	AL00000204	HEX NUT M6		3		
A01	AL00000044	WRENCH 8-19		1	*	
A01-1	AL00000044	WRENCH 8-19	O	1		
A02	AL00000045	WRENCH 10-13		1	*	
A02-1	AL00000045	WRENCH 10-13	O	1		
A03	A-47195	GRINDING WHEEL (BENCH,150)		1	*	
A03-1	B-51895	GRINDING WHEEL (BENCH,150)	O	1		
A04	A-47210	GRINDING WHEEL (BENCH,150)		1	*	
A04-1	B-51926	G-WHEEL WA 60 150X16X12.7	<	1	*	
A04-2	B-51926	G-WHEEL WA 60 150X16X12.7	O	1		
E01	AL00000301	LEAD WIRE ASSY BLACK		1		
E02	654510-5	INSULATED CONNECTOR 5.5-SD		1		
E03	654509-0	CONNECTOR 2-SD		1		
E04	687010-0	BAND		2		
F01	AL00000147	SAFETY GOGGLE		1	*	
F01-1	AL00000147	SAFETY GOGGLE	O	1	*	

Please state Parts No. when your order.

Print Date 07/22/2024